

M12, female, angled, 3+PE, S-coded, M12, male, angled, 3+PE, S-coded, rail approved

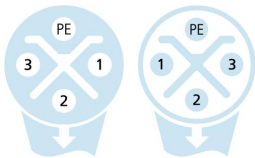
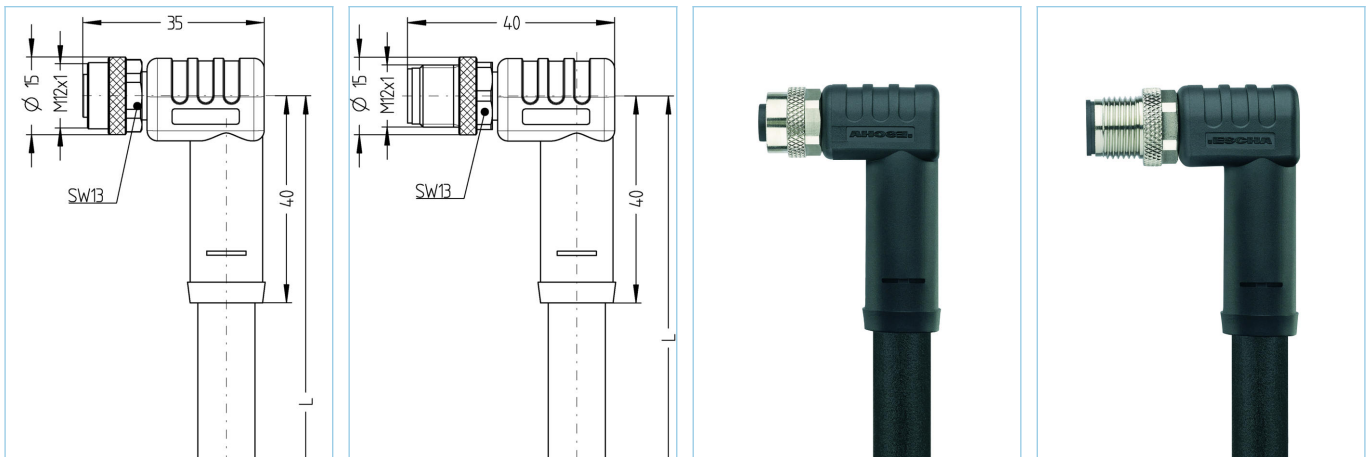

Product data

Item description	RA-PSWM12K4. 189-1-RA-PSWM12S4. 189/S4600
Item-No.	8121053
Length	1m
Customs tariff-No.	85444290
Step-File	RA-PSWM12K4-m-RA-PSWM12S4_S4600.stp
EAN	4047106336981

Technical data

	A-side	B-side
Connector	female, angled, M12	male, angled, M12
Number of pins	3+PE	3+PE
Pin assignment	1 WH, 2 WH, 3 WH, 4 GNYE	1 WH, 2 WH, 3 WH, 4 GNYE
Coding of	S	S
Rated voltage	630V _{AC} 600V _{AC} (UL)	630V _{AC} 600V _{AC} (UL)
Current load (at 40°C)	12A	12A
Insulation resistance	≥10 ⁸ Ω	≥10 ⁸ Ω
Contact material	Metal, CuZn, gold-plated	Metal, CuZn, gold-plated
Contact-carrier material	Plastic, PA, BK	Plastic, PA, BK
Grip body material	Plastic, TPU, BK	Plastic, TPU, BK
Coupling nut material	Metal, CuZn, nickel-plated	Metal, CuZn, nickel-plated
Sealing (female) material	FPM/FKM	FPM/FKM
Standards	IEC 61076-2-111	IEC 61076-2-111
Degree of protection (mounted)	IP65, IP67, IP68	IP65, IP67, IP68
Mechanical life-cycle	>100 mating cycles	>100 mating cycles
Degree of pollution	2	2

Cable web
RADOX®, 4x1.5mm², S4600

Halogen-free, electron-beam cross-linked cable with improved behaviour in case of fire, easy to strip, soldering resistant and flexible. The cable is intended for fixed, mechanically protected installation inside railway vehicles or for installation in applications where limited alternating bending stresses occur during operation. It fulfills the requirements according to EN 50306-4 and EN 45545-2 (HL1 - HL3). Wire cross-section: 1.5mm². RADOX® is a registered trademark of HUBER+SUHNER AG, Switzerland.

Outer diameter of jacket	6.7 mm
Cable-jacket material	RADOX® EM 104
Jacket color	BK, similar RAL9005
Wire cross-section	4 x 1.5 mm ²
Wire insulation material	RADOX® EI 306
Wire colors	WH 1, WH 2, WH 3, GNYE
Wire structure	19 x 0.31 mm
Bending radius (fixed)	3 x Ø-cable
Bending radius (repeated)	4 x Ø-cable
Temperature range (fixed)	-40°C...+120°C
Halogen-free	Yes
Rated voltage cable	VDE U0/U: 300V/500V
Special features	flame retardant, halogen free, LABS free, microbes resistant, oil- and fuel resistant, ozone resistant, recyclable, RoHs compliant, acid- and alkali resistant, welding sparks resistant, seawater resistant, UN ECE R 118, UV resistant

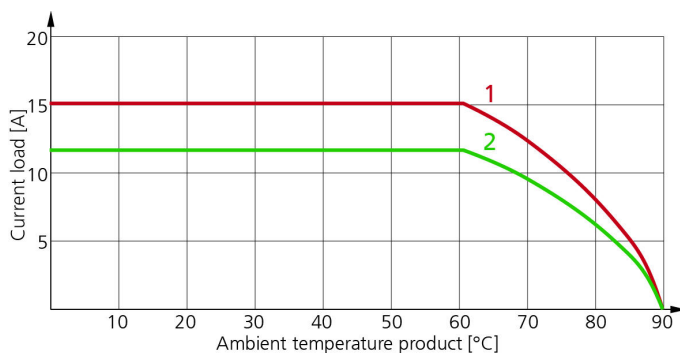
Derating curve according to DIN 60512-5-2

1: Base curve

2: Derived curve according to DIN 60512-5-2 with correction factor 0,8

Accessories
Mounting-set, M12
<https://www.escha.net/en/products/standard/accessories-for-connectivity/8047664>
Torque-wrench set
<https://www.escha.net/en/products/standard/accessories-for-connectivity/8055431>
Marking rings Ø 9mm
<https://www.escha.net/en/products/standard/accessories-for-connectivity?p=1&o=3&n=15&f=809>
Screw plug, M12
<https://www.escha.net/en/products/standard/accessories-for-connectivity?p=1&o=3&n=15&f=812>
Screw cap, M12
<https://www.escha.net/en/products/standard/accessories-for-connectivity?p=1&o=3&n=15&f=811>
Link to product
<https://www.escha.net/en/8121053>