

Valve connector, housing style A, angled, 2+PE bridged, grip body with thread, with LED, rail approved

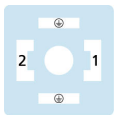
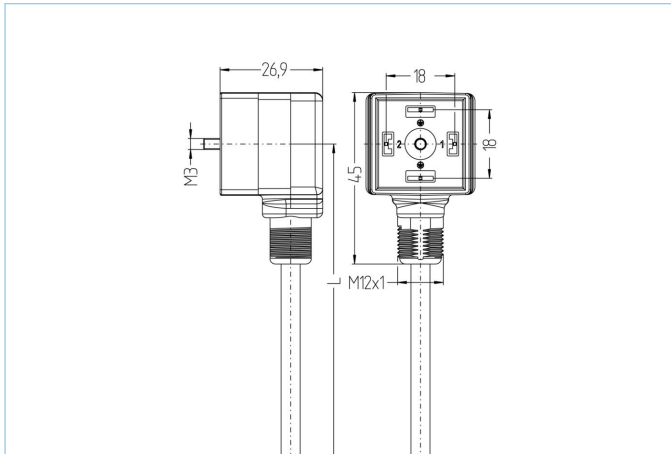

**Product data**

Item description	RA-VAG22.1-24.1-5/S5600
Item-No.	8116609
Length	5m
Customs tariff-No.	85444290
Step-File	RA-VAG22_1-24_1-m.stp
EAN	4047106322953

**Technical data**

Connector	female, angled, Valve A, with LED, grip body with thread
Number of pins	2+PE, PE bridged
Pin assignment	1 WH1, 2 WH2, PE: GNYE
Rated voltage	30V <sub>AC/DC</sub>
Current load per pin (at 40°C)	10A
Insulation resistance	≥10 <sup>9</sup> Ω
Signal status-indicator	LED YE
Contact material	Metal, CuZn, silver-plated
Contact-carrier material	Plastic, PA, BK
Grip body material	Plastic, PA, BK
Sealing (female) material	Plastic, NBR
Protection circuit	without
Fixing screw	Metal, CuZn, nickel-plated
Housing style	A
Standards	DIN EN 175301-803
Degree of protection (mounted)	IP65, IP67
Mechanical life-cycle	>100 mating cycles
Degree of pollution	3
Style	angled

### Advanced technical data rail approved

Standards	DIN EN 50155, DIN EN 45545-2
Shock & vibration	Class 1, Category B (DIN EN 61373)
Temperature range	Tx (-40°C...+90°C)
Fire prevention according to	DIN EN 45545-2 HL1-3

### Cable web **ÖLFLEX® TRAIN, 3x0,75mm², S5600**

Halogen-free, highly flame-resistant cable for fixed, mechanically protected installation in railway vehicles. The cable fulfils the requirements according to EN 45545-2 (HL1 – HL3). It is characterized by a wide temperature range. ÖLFLEX® is a registered trademark of Lapp GmbH, Germany.

Outer diameter of jacket	4.7 mm
Cable-jacket material	flame retardant, halogen free polymer-compound
Jacket color	BK
Wire cross-section	3 x 0.75 mm²
Wire insulation material	Polymer compound
Wire colors	WH 1, WH 2, GNYE
Wire structure	37 x 0,16 mm
Bending radius (fixed)	4xØ-cable
Bending radius (repeated)	5xØ-cable
Temperature range (repeated)	-35°C...+105°C
Temperature range (fixed)	-45°C...+125°C
Fire prevention according to	DIN EN 45545-2 HL1-3
Halogen-free	Yes
Special features	flame retardant, halogen free, oil- and fuel resistant, acid- and alkali resistant

### Classification

eCl@ss 6.0	27279218
eCl@ss 7.0	27279218
eCl@ss 8.0	27279218
eCl@ss 9.0	27060312
ETIM 5.0	EC001855
ETIM 6.0	EC001855

### Accessories

#### Labels, Valve connector

<https://www.escha.net/en/products/standard/accessories-for-connectivity/8047109>

#### Adapter piece, M12

<https://www.escha.net/en/products/standard/accessories-for-connectivity/8081747>

#### Protective hose

<https://www.escha.net/en/products/standard/accessories-for-connectivity/8081621>