

OI98C156

TEMPERATURE SENSORS • CONTACTLESS MEASUREMENT (INFRARED)



MECHANICAL DATA

Ambient temperature (MAX)	65 °C
Cable length of measuring head	1 m
Degree of protection (IP)	IP65
Housing material	Stainless steel
Measurement of material humidity	No
Operating temperature of the measuring head	130 °C
Operating temperature of the measuring head	-20 °C
Sensor height	70 mm
Sensor length	30 mm
Sensor width	110 mm

ELECTRICAL DATA

Data logging possible	Yes
Display	Digital
Infrared measurement	Yes
Interface	No
Interface possible	Yes
Measured value memory	No
Measurement of differential temperature	No
Measurement of rel. air humidity	No
Measuring range	-40 °C ... 600 °C
Multiple display	No
No-load current	100 mA
Operating voltage	8 V ... 36 V
Programmable via software	Yes
Relative repeat accuracy	0.5 %
Response time	150 ms
Response/decay time	150 ms
Separate sensor	No
Setting procedure	Parameterization
Temperature drift	0.05 %

ELECTRICAL DATA

Thermocouple RTD	No
Type B thermocouple	No
Type E thermocouple	No
Type J thermocouple	Yes
Type K thermocouple	Yes
Type N thermocouple	No
Type of analog output	0 / 4 ... 20 mA, 0 ... 5 / 10 V
Type of electrical connection	Clamp
Type of switching function	Normally open contact (NO)
Type of switching output	NPN
Type R thermocouple	No
Type S thermocouple	No
Type T thermocouple	No
With LED display	Yes

OPTICAL DATA

Light spot diameter	400 mm
Light spot diameter	5 mm
Ratio (D:S)	2:1
Spectral sensitivity	14 µm
Spectral sensitivity	8 µm

CONNECTION

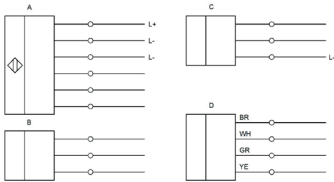

Colors: D: BN = (brown), WH = (white), GN = (green), YE = (yellow)

Functions: A: L+, L-, L-, OUT-AMB, OUT-TC, OUT-mV/mA

B: F1, F2, F3

C: alarm 2, 3V, L-

DIMENSIONAL DRAWING

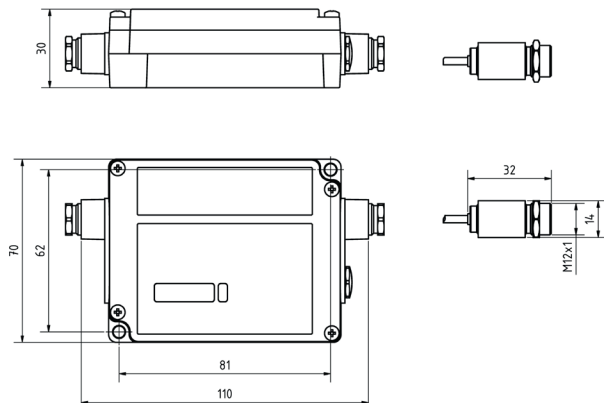

INSTALLATION



Mounting / Installation may only be carried out by a qualified electrician!

DISPOSAL



SAFETY WARNINGS

Before initial operation, please make sure to follow all safety instructions that may be provided in the product information!