

M8-Round-Plug Connector, Single-Ended Cordsets
RSMV 3 | RSMV 4 | RSMWV 3 | RSMWV 4

RSMV | RSMWV



3- and 4-Poles

Actuator/sensor cordset, single-ended, M8, 3- and 4-poles male straight connector with self-locking threaded joint and molded cable.

RSMV

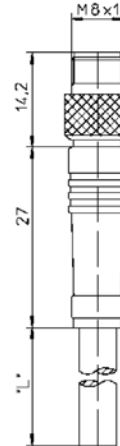

Actuator/sensor cordset, single-ended, M8, 3- and 4-poles male 90° connector with self-locking threaded joint and molded cable.

RSMWV

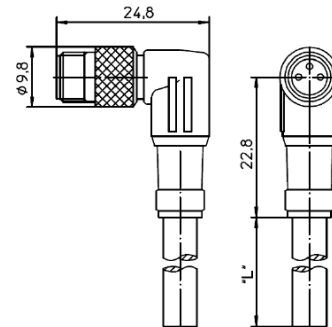

Pin Assignments

M8

3 poles

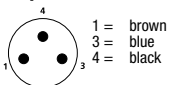

4 poles

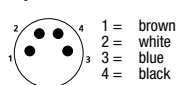

Be Certain with Belden

Cordsets
Single-Ended



M8-Round-Plug Connector, Single-Ended Cordsets

RSMV 3 | RSMV 4 | RSMWV 3 | RSMWV 4

Technical Data

Environmental

Degree of protection IP 67, IP68 (NEMA 6P)
Operating temperature range -30 to +80C

Mechanical

Housing / Molded body TPU grey transparent
Insert (contact bearer) PA/TPU, orange
Contact Copper Alloy
Coupling screw Nickel Plated Brass
O-ring n/a





Electrical data

Rated voltage 63V (IEC) / 30V (UL)
Rated current* 4 A

Cable Specifications

Cable No.	Outer Jacket	Conductor Size	Jacket Color	OD
294	PVC	22 AWG stranded	black	5.00 mm nominal
295	PVC	22 AWG stranded	black	5.20 mm nominal

Cordsets
Single-Ended

Part Number		Pins	Outer Jacket	Standard Cable Lengths	Characteristics
Male Straight	Male 90°				
RSMV 3-294/...M	RSMWV 3-294/...M	3	PVC	2M / 5M / 10M	   
RSMV 4-295/...M	RSMWV 4-295/...M	4	PVC	2M / 5M / 10M	