

VK100F21

CONNECTION TECHNOLOGY • CABLE SOCKETS /CONNECTORS TWO-SIDED PRE-ASSEMBLED

ipf cable sockets are used primarily for establishing the electrical connection of sensors. Their features are characterized by rugged design, the highest protection classes (IP67 | IP68 | IP69K) and, if desired, with 360° shielding. With the features: bus-ready, suitable for use with drag chains and robots, resistance to oil and chemicals, resistance to welding sparks, their resistance to cleaning agents or high-pressure and steam-jet cleaning, the expanded temperature range of up to +230°C, the rapid interconnection technology and special data transmission properties, the cable sockets meet all requirements in automation technology.



MECHANICAL DATA

Cable length	1 m
Degree of protection (IP)	IP67
Material of cable sheath	PUR (Polyurethane)
Number of wires	4
Perm. ambient temperature of cable, fixed cable (MAX)	80 °C
Perm. ambient temperature of cable, fixed cable (MIN)	-25 °C
Positioning of cable feed, field side	Angled
Positioning of cable feed, housing side	Straight
Suitable for trailing chain	Yes
Wire assembly	42 x 0.1mm
Wire cross section	0.34 mm ²

ELECTRICAL DATA

Number of pins	4
Rated voltage	240 V
Type of electrical connection, field side	M12
Type of electrical connection, housing side	M12
Type of plug-in contact, field side	Female (socket)
Type of plug-in contact, housing side	Male (plug)

OTHER DATA

Flame resistant	In accordance with EN 60332-2-2
Free of LABS	Yes
Halogen-free	Yes
Hydrolysis-proof	Yes
IR-networked	No
Oil and cooling lubricants	Yes
Ozone and UV-resistant	Yes
RoHS-compliant	Yes
Silicone-free	Yes
Suitable for trailing chain and torsion resistant	Yes

OTHER DATA

Welding area

Yes

CONNECTION

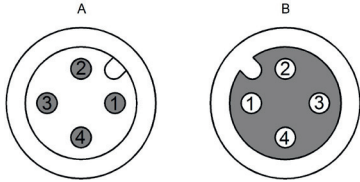

Colors: A: 1 = BN (brown), 2 = WH (white), 3 = BU (blue), 4 = BK (black)

B: 1 = BN (brown), 2 = WH (white), 3 = BU (blue), 4 = BK (black) **Functions:**

DIMENSIONAL DRAWING

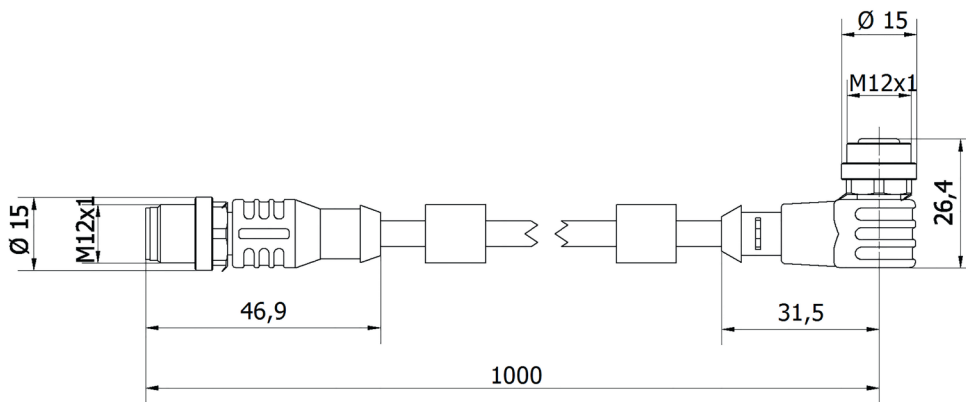

INSTALLATION



Mounting / Installation may only be carried out by a qualified electrician!

DISPOSAL



SAFETY WARNINGS

Before initial operation, please make sure to follow all safety instructions that may be provided in the product information!

Never use these devices in applications where the safety of a person depends on their functionality.