

IB5001T1

INDUCTIVE SENSORS • ENLARGED AMBIENT TEMPERATURE

Inductive proximity switches are contact-free sensors. They detect all conductive metals, regardless of whether they move or not. The achievable sensing range of the devices depends on the object material and its dimensions. The vibration-resistant sensors can be approached laterally or frontally. Inductive proximity switches are used for presence detection (e.g. goods carriers), positioning (e.g. dampers), counting (e.g. nuts /bolts), speed detection (e.g. for cog wheels), on conveyor systems (e.g. hose feedings) or distance measurements (e.g. press-in checking) of metallic objects.

MECHANICAL DATA

Active area material of sensor	Vectra®
Ambient temperature (MAX)	180 °C
Cable length	5 m
Degree of protection (IP)	IP50
Housing design	Cylinder, screw-thread
Housing material	Stainless steel 1.4305
Increased ambient temperatures > 80°C	Yes
Material of cable sheath	PTFE
Mechanical mounting condition for sensor	Flush
Pressure-proof	No
Sensor length	70 mm
Thread length	60 mm
Thread pitch	1.5 mm
Thread size, metric	50
Wire cross section	0.25 mm ²

ELECTRICAL DATA

Cascadable	No
Hysteresis	15 %
IO-Link compatible	No
Max. output current	150 mA
No-load current	15 mA
Norm measuring plate	50x50x1
Readiness delay	10 ms
Relative repeat accuracy	3 %
Residual ripple	10 %
Response time	5 ms
Reverse polarity protection	Yes
Short-circuit-proof	Yes
Suitable for safety functions	No
Supply voltage	10 V ... 35 V

ELECTRICAL DATA

Switching distance	20 mm
Switching frequency	100 Hz
Type of electrical connection	Cable
Type of switching function	Normally open contact
Type of switching output	PNP
Voltage drop	2 V
Voltage type	DC
With monitoring function of downstream devices	No

CONNECTION

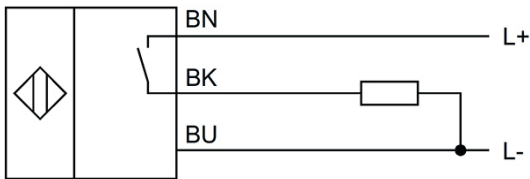

Colors: BN (brown), BU (blue), BK (black)
Functions: BN = L+, BU = L-, BK = PNP NO

DIMENSIONAL DRAWING

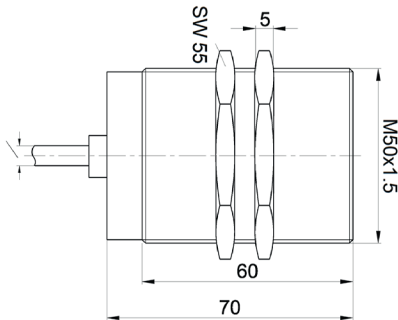

INSTALLATION



Mounting / Installation may only be carried out by a qualified electrician!

DISPOSAL



SAFETY WARNINGS

Before initial operation, please make sure to follow all safety instructions that may be provided in the product information!