

## OY410524

### OPTICAL SENSORS • LIGHT BARRIERS

The multi-function light barriers are through-beam sensors where multiple beams are integrated. In case of interruption of only one beam, the switching output of the receiver changes its state. The devices are used where standard through-beam sensors with only one beam are not sufficient. There are devices with beam spacing of 20, 40, 60 or 120mm and different heights available. An integrated fuzzy logic controls the transmitting power automatically.



#### MECHANICAL DATA

Ambient temperature (MAX)	50 °C
Ambient temperature (MIN)	-5 °C
Cover material	Plastic
Degree of protection (IP)	IP65
Housing material	Aluminium
Material of optical surface	PMMA
Protected field height	75 mm
Sensor height	100 mm
Sensor length	20.5 mm
Sensor width	40 mm

#### ELECTRICAL DATA

Cascadable	No
Clock control possible	No
Max. output current	80 mA
No-load current, receiver	60 mA
No-load current, transmitter	60 mA
Number of pins, receiver	4
Number of pins, transmitter	4
Number of semiconductor outputs with signaling function	2
Override possible	No
Rated control supply voltage $U_s$ at DC (MAX)	26.4 V
Rated control supply voltage $U_s$ at DC (MIN)	21.6 V
Reaction time	0.8 ms
Reverse polarity protection	Yes
Short-circuit-proof	Yes
Suitable for safety functions	No
Suppression possible	No
Switching output type of the OSSD	PNP/NPN
Type of electrical connection	Connector M12
Type of switching function	Anticoincidence

## ELECTRICAL DATA

Type of switching output	PNP/NPN
Voltage type	DC
With monitoring function of downstream devices	No
With muting function	No
With restart lock	No

## OPTICAL DATA

Min. distance	0.08 m
Protected field range	0.8 m
Resolution of the light curtain	2 mm

## OTHER DATA

Explosion protection category for dust	None
Explosion protection category for gas	None
Reduced resolution	No
Scope of delivery of the one-way system	Transmitter and receiver
With beam coding	No

## CONNECTION

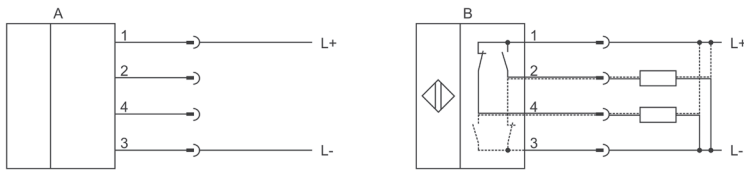

**Colors:** A: 1 = BN (brown), 2 = WH (white), 3 = BU (blue), 4 = BK (black)

B: 1 = BN (brown), 2 = WH (white), 3 = BU (blue), 4 = BK (black) **Functions:** A: 1 = L+, 2 = n. c., 3 = L-, 4 = n. c.

B: 1 = L+, 2 = PNP NO / NPN NC, 3 = L-, 4 = PNP NC / NPN NO

## DIMENSIONAL DRAWING

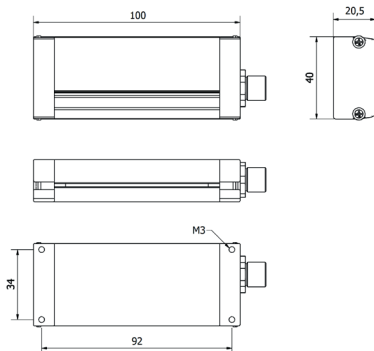

## INSTALLATION



Mounting / Installation may only be carried out by a qualified electrician!

## DISPOSAL



**SAFETY WARNINGS**

Before initial operation, please make sure to follow all safety instructions that may be provided in the product information!

Never use these devices in applications where the safety of a person depends on their functionality.