

O198C503

TEMPERATURE SENSORS • CONTACTLESS MEASUREMENT (INFRARED)



MECHANICAL DATA

Ambient temperature (MAX)	65 °C
Degree of protection (IP)	IP65
Measurement of material humidity	No
Operating temperature of the measuring head	85 °C
Operating temperature of the measuring head	-20 °C

ELECTRICAL DATA

Data logging possible	Yes
Display	Digital
Infrared measurement	Yes
Interface	No
Interface possible	Yes
Measured value memory	No
Measurement of differential temperature	No
Measurement of rel. air humidity	No
Measuring range	-40 °C ... 975 °C
Multiple display	No
No-load current	160 mA
Operating voltage	8 V ... 36 V
Programmable via software	Yes
Relative repeat accuracy	0.5 %
Separate sensor	No
Thermocouple RTD	No
Type B thermocouple	No
Type E thermocouple	No
Type J thermocouple	Yes
Type K thermocouple	Yes
Type N thermocouple	No
Type R thermocouple	No
Type S thermocouple	No
Type T thermocouple	No

ELECTRICAL DATA

With LED display

Yes

OPTICAL DATA

Small measuring spot

Yes

CONNECTION

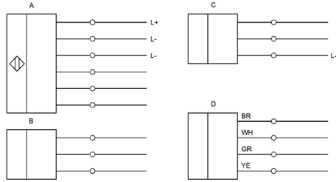

Colors: D: BN = (brown), WH = (white), GN = (green), YE = (yellow)

Functions: A: L+, L-, L-, OUT-AMB, OUT-TC, OUT-mV/mA

B: F1, F2, F3

C: alarm 2, 3V, L-

DIMENSIONAL DRAWING

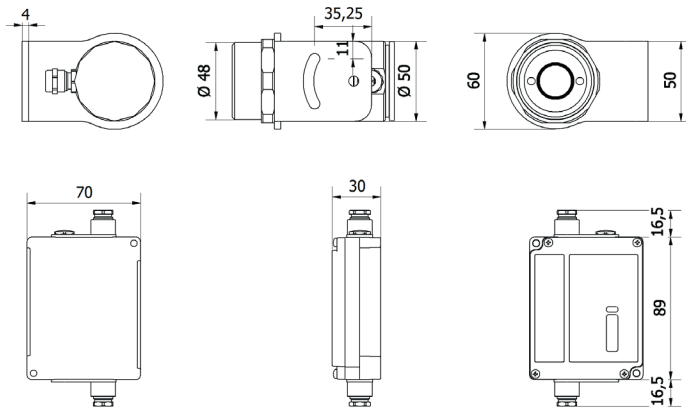

INSTALLATION



Mounting / Installation may only be carried out by a qualified electrician!

DISPOSAL



SAFETY WARNINGS

Before initial operation, please make sure to follow all safety instructions that may be provided in the product information!